

Teddy Bear 2015

Created by Shoko Aoyagi
Diagrams by Shoko Aoyagi

© Shoko Aoyagi September 2015

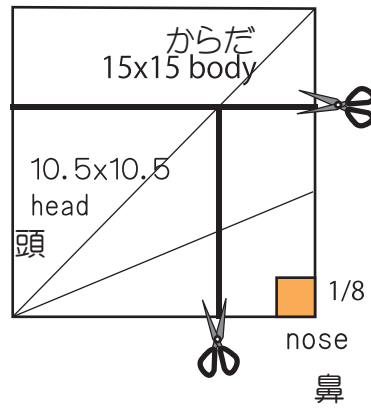

Body (からだ)

1

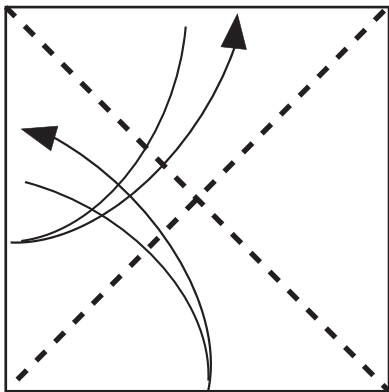

2

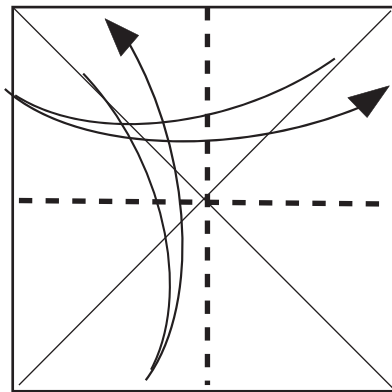

3

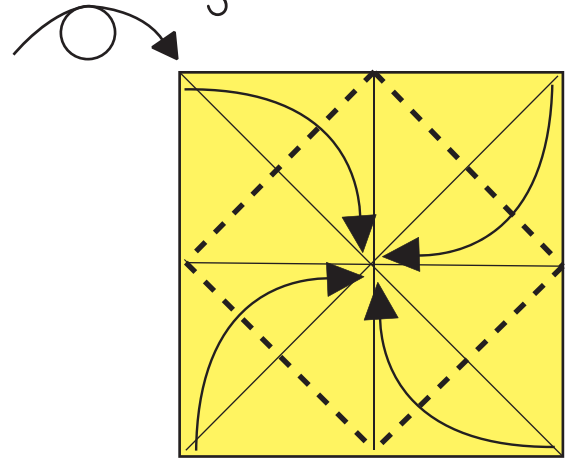

4

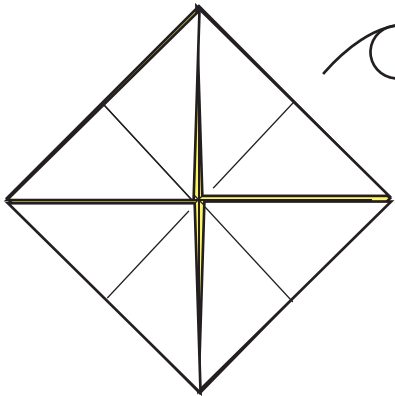

5

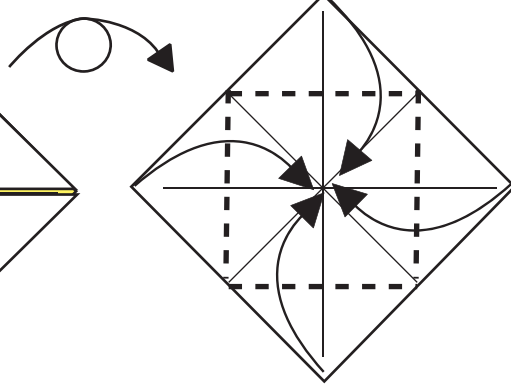

6

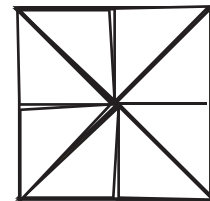

Unfold
開く。

7

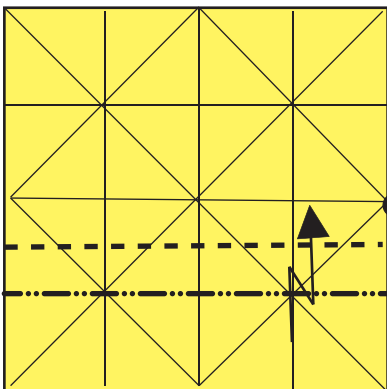

8

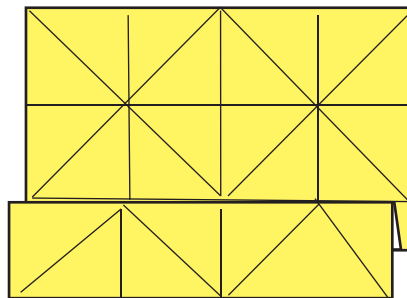

9

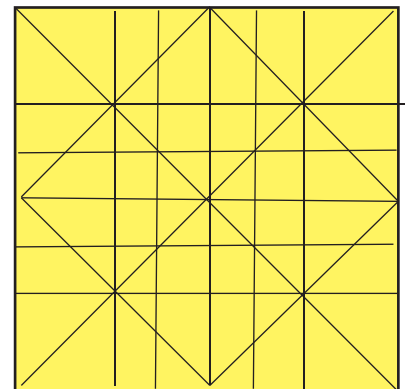

Body (からだ)

10

11

12

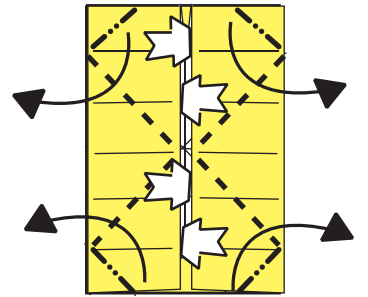
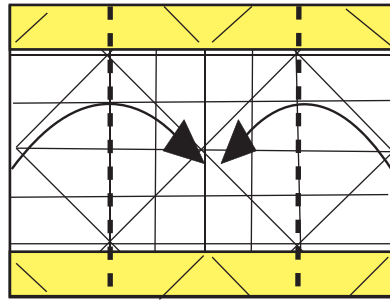
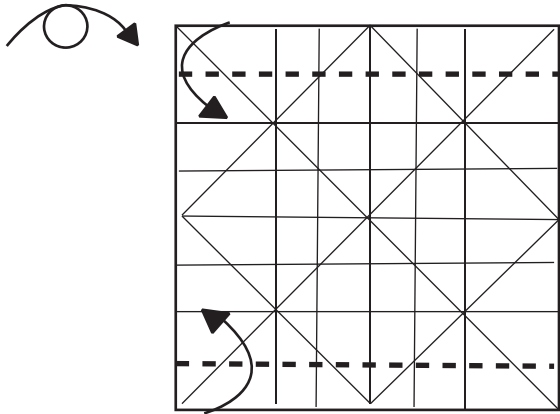

13

14

15

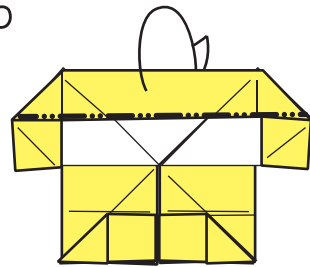
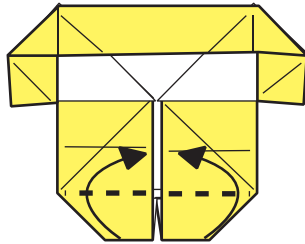
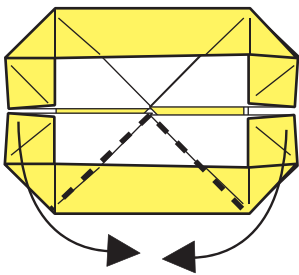

16

17

18

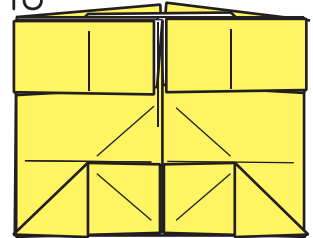
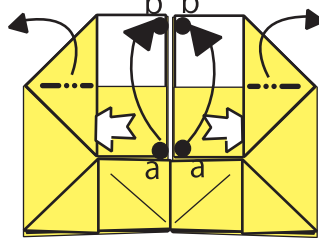
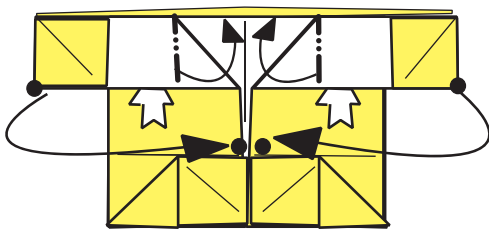

19

20

21

(ポケット)
Pocket

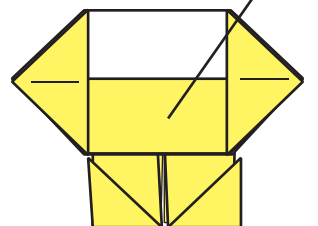
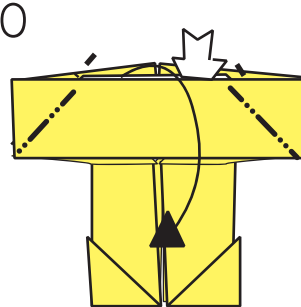
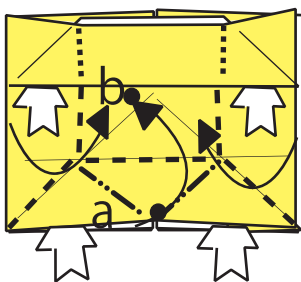

Head (頭)

1

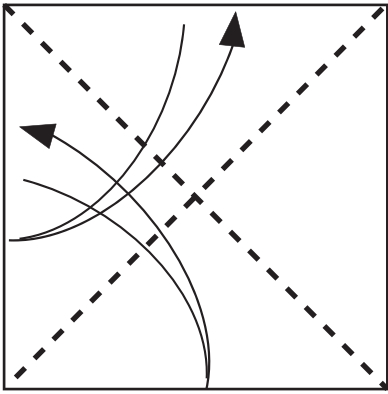

2

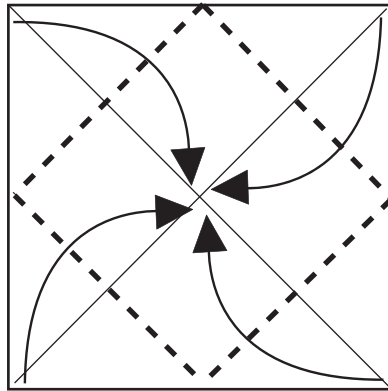

3

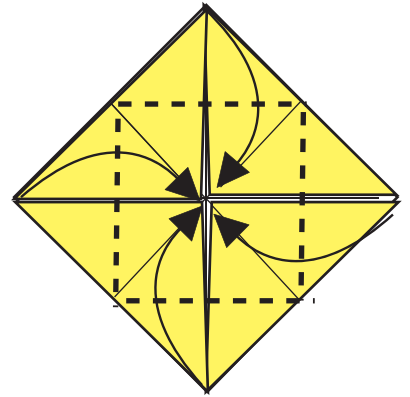

4

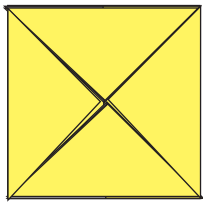

Unfold
(開く)

5

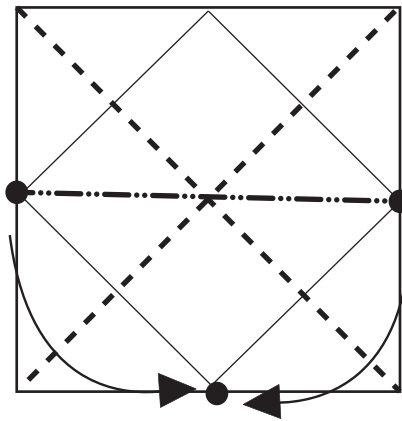

6

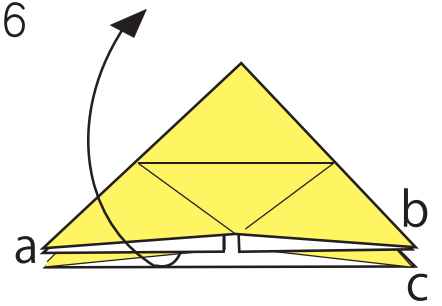

Separate the layer
of b and c and
make a triangle.

7

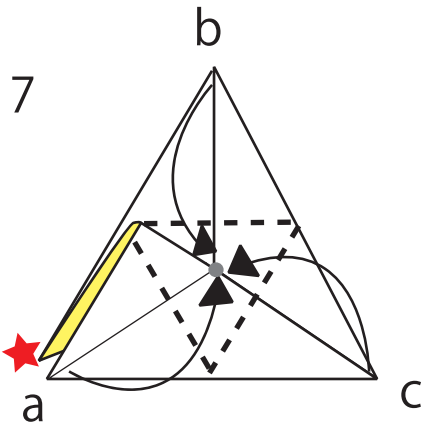

The centre is
recessed.

(中央は凹んでいる)

8

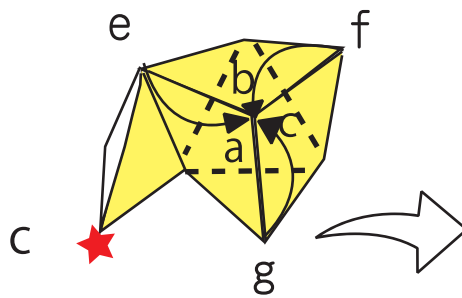

9

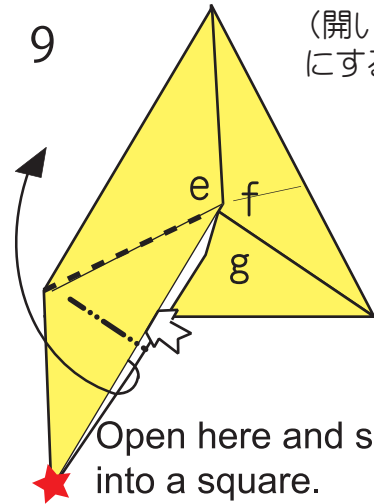

(開いて、#7の形
にする。)

Open here and squash fold
into a square.

10

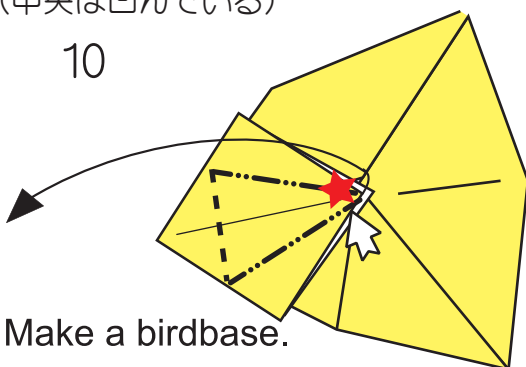

Make a birdbase.

(鶴の基本形を折る)

11

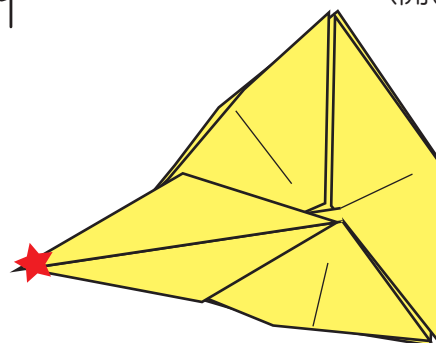

(開いて、正方基本形)

Head (頭)

12

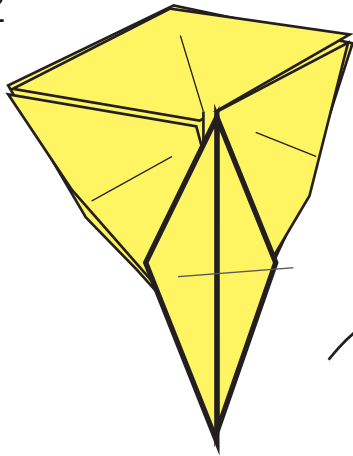

13

② Mountain fold
山折り

① Valley fold
谷折り

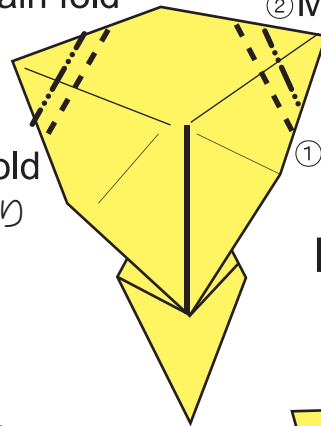

② Mountain fold
山折り

① Valley fold
谷折り

Make ears.

14

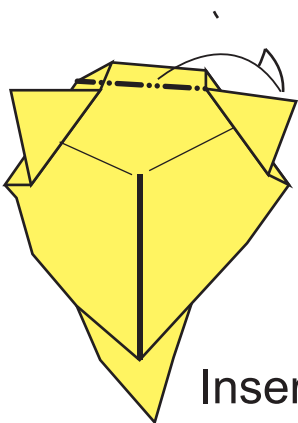

Insert the nose
under the slit.

鼻のAを、隙間に差し込む。

15

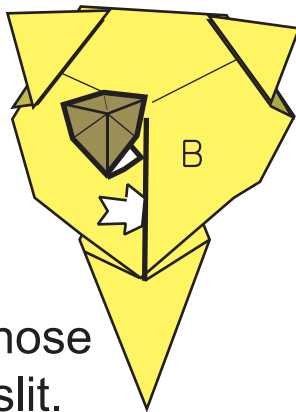

16

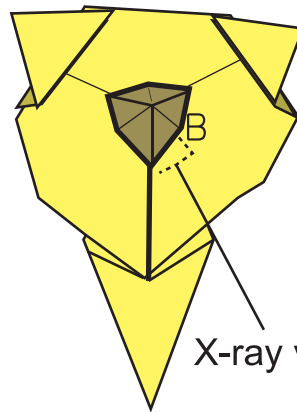

X-ray view

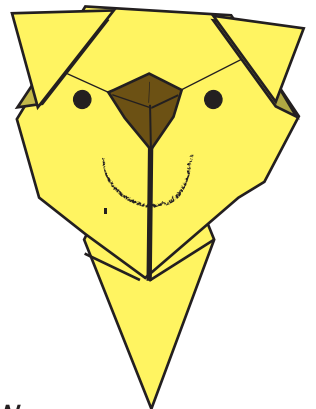

Complete.

完成

Make the nose. (鼻の作り方)

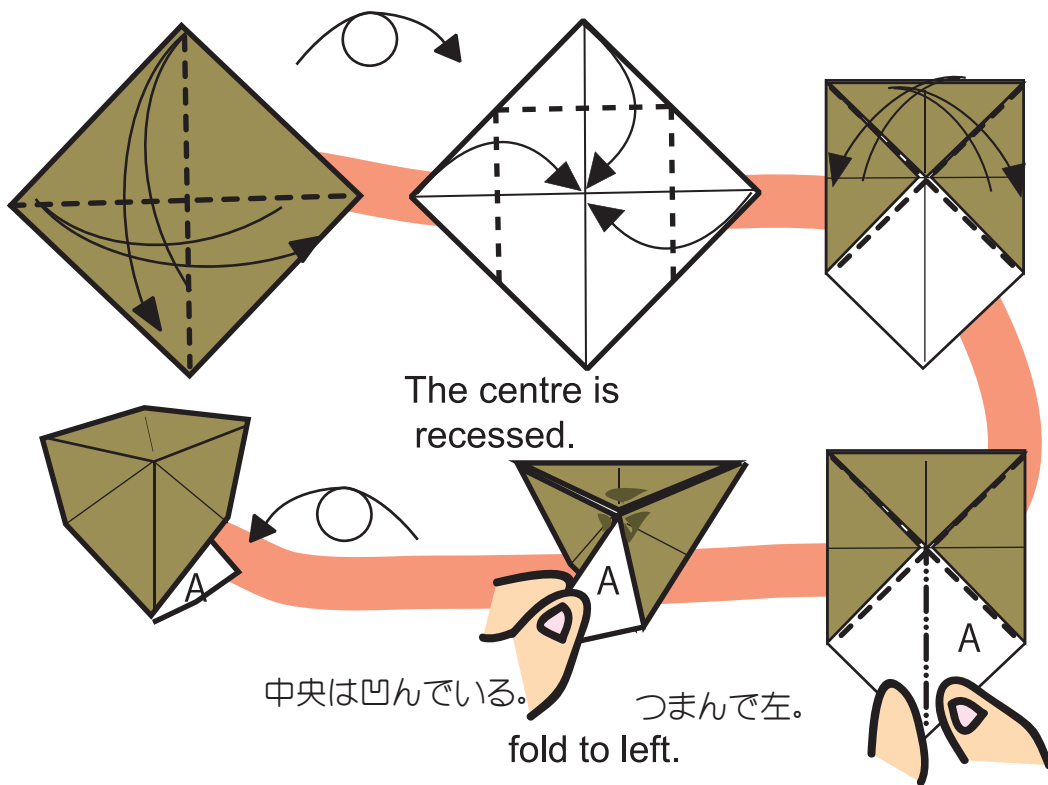

The centre is
recessed.

中央は凹んでいる。

つまんで左。
fold to left.

How to assemble

(頭と、体を組み合わせよう!)

1

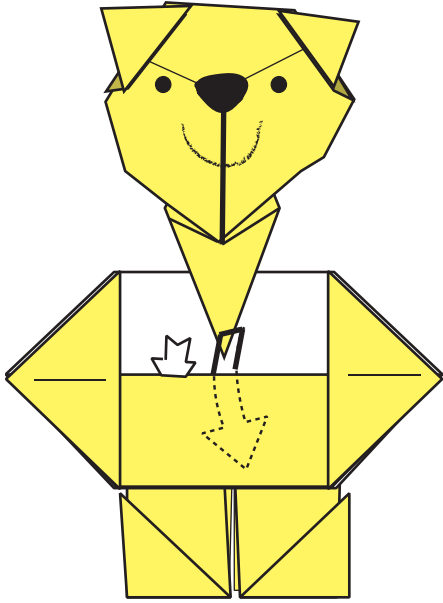

2

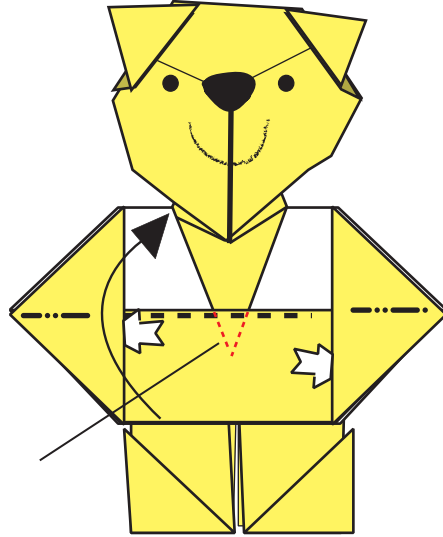

3

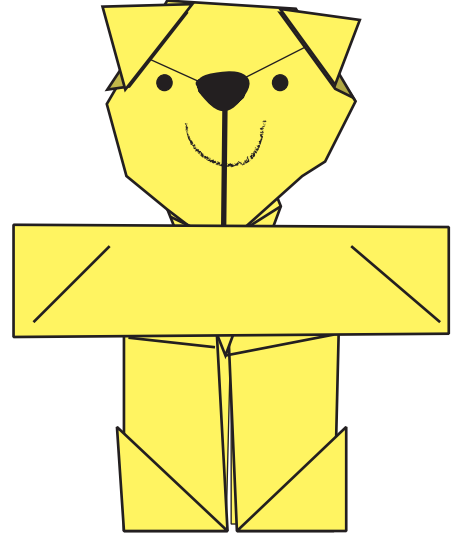

4

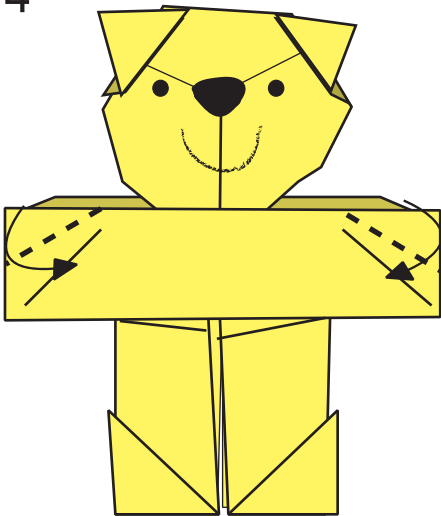

5

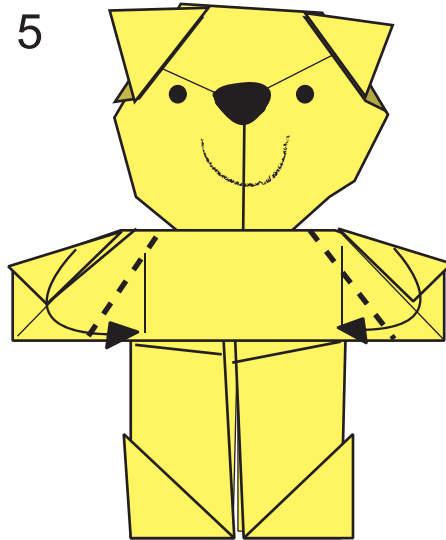

6

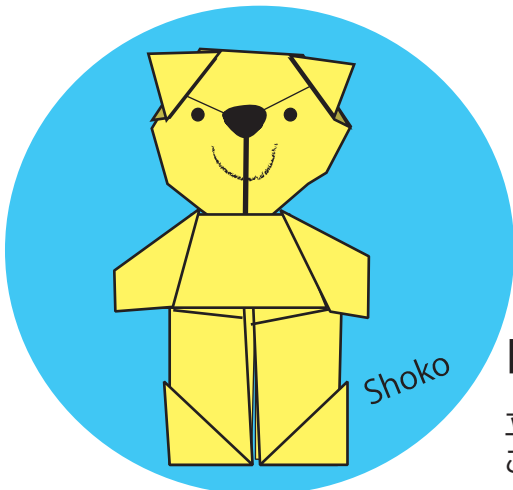
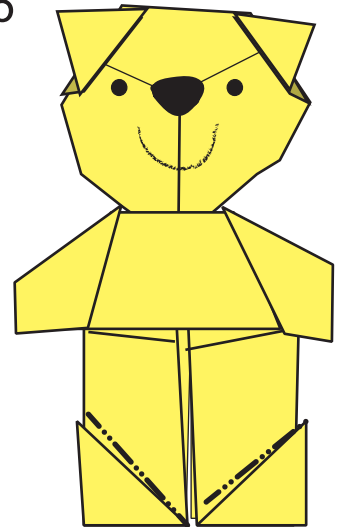

It can stand!

Hello Teddy!

立ちますよ。
こんにちはくまさん!



How to cut the paper for the Head.

頭の切り出し方

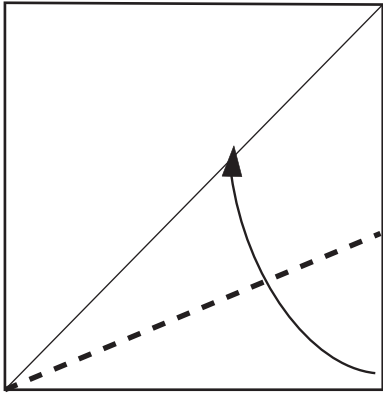

最初は、20cmなどやや大きめの紙で作った方がいいでしょう。

