

# こぶたちゃんの指人形

1/2

©Shoko Aoyagi 2004

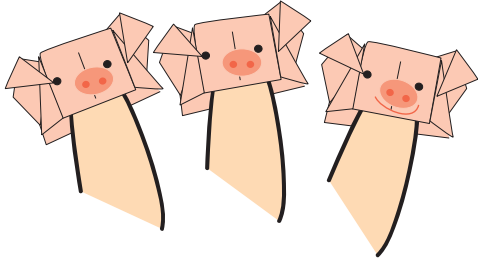

おりがみ用紙 ひとつにつき 1枚。  
こぶたちゃんの顔を描くペン。

1

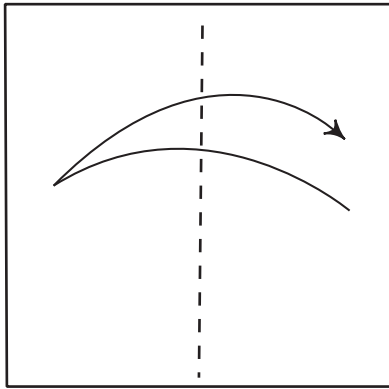

2

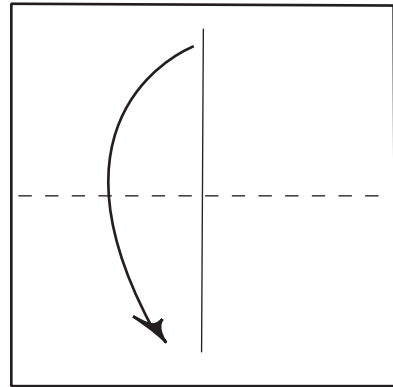

3

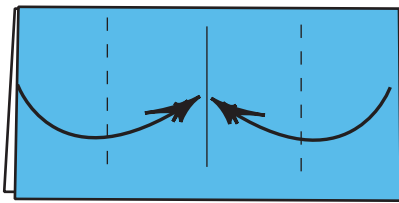

4

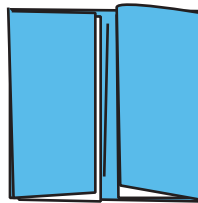

5

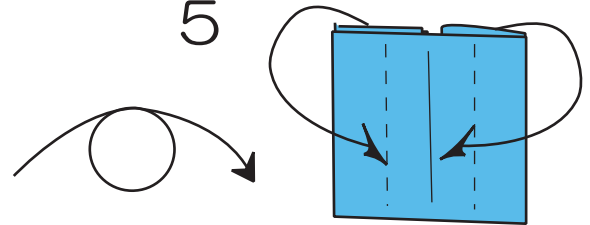

6

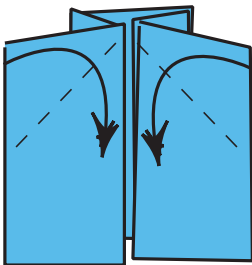

7

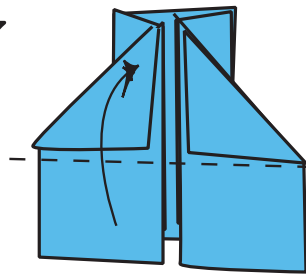

8



9

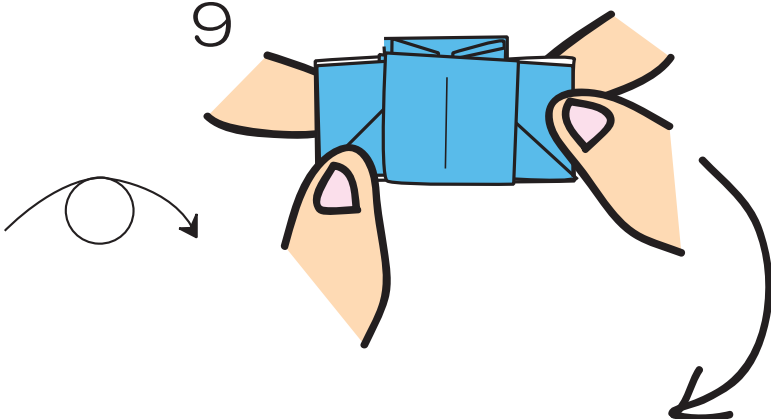

10

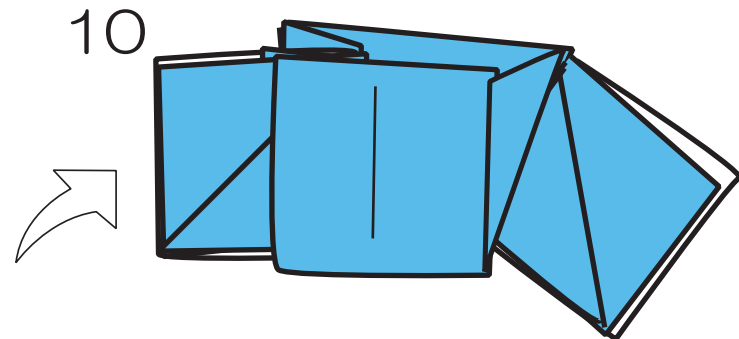

## こぶたちゃんの指人形

©Shoko Aoyagi 2004

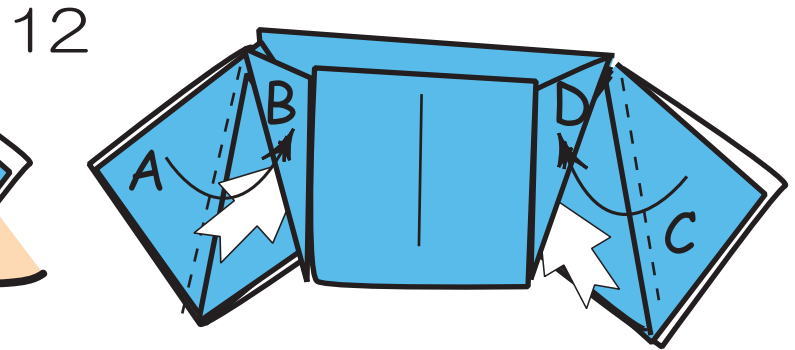
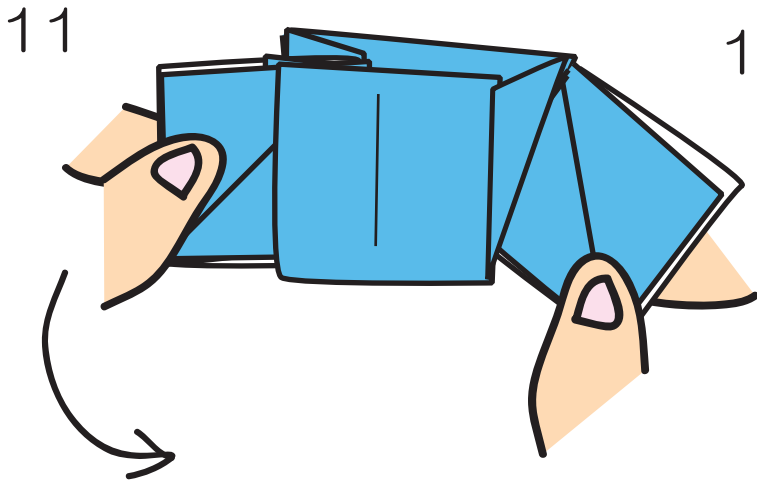

AをBの下に入れ込む。  
CをDの下に入れ込む。

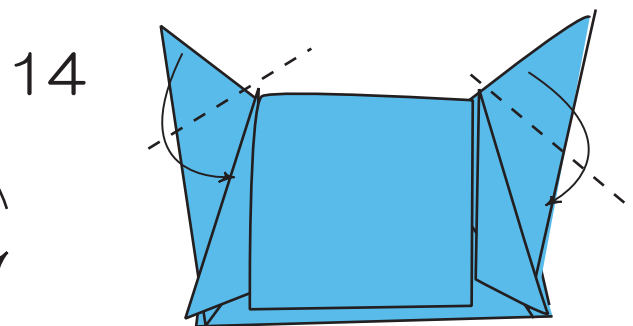
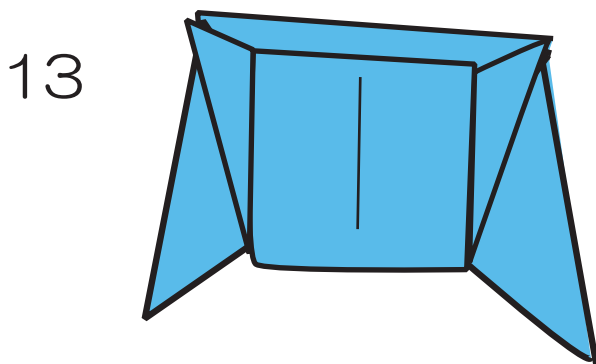

こぶたちゃんの顔を描きましょう。さあ、パペットショーの始まり。！

